

BERKELEY®

VERTICAL LINESHAFT TURBINES

No. Stages	Eff.
1	-2
2	-1
3	0
4	0

12VT900 CLOSED IMPELLER 1770 R.P.M.

SINGLE STAGE LAB PERFORMANCE WITH STANDARD MATERIALS. EFFICIENCY SHOWN FOR 4 OR MORE STAGES. HORSE POWER SHOWN FOR ONE STAGE BASED ON 4 STAGE EFFICIENCY. CORRECTIONS SHOULD BE MADE FOR STAGES AND MATERIAL

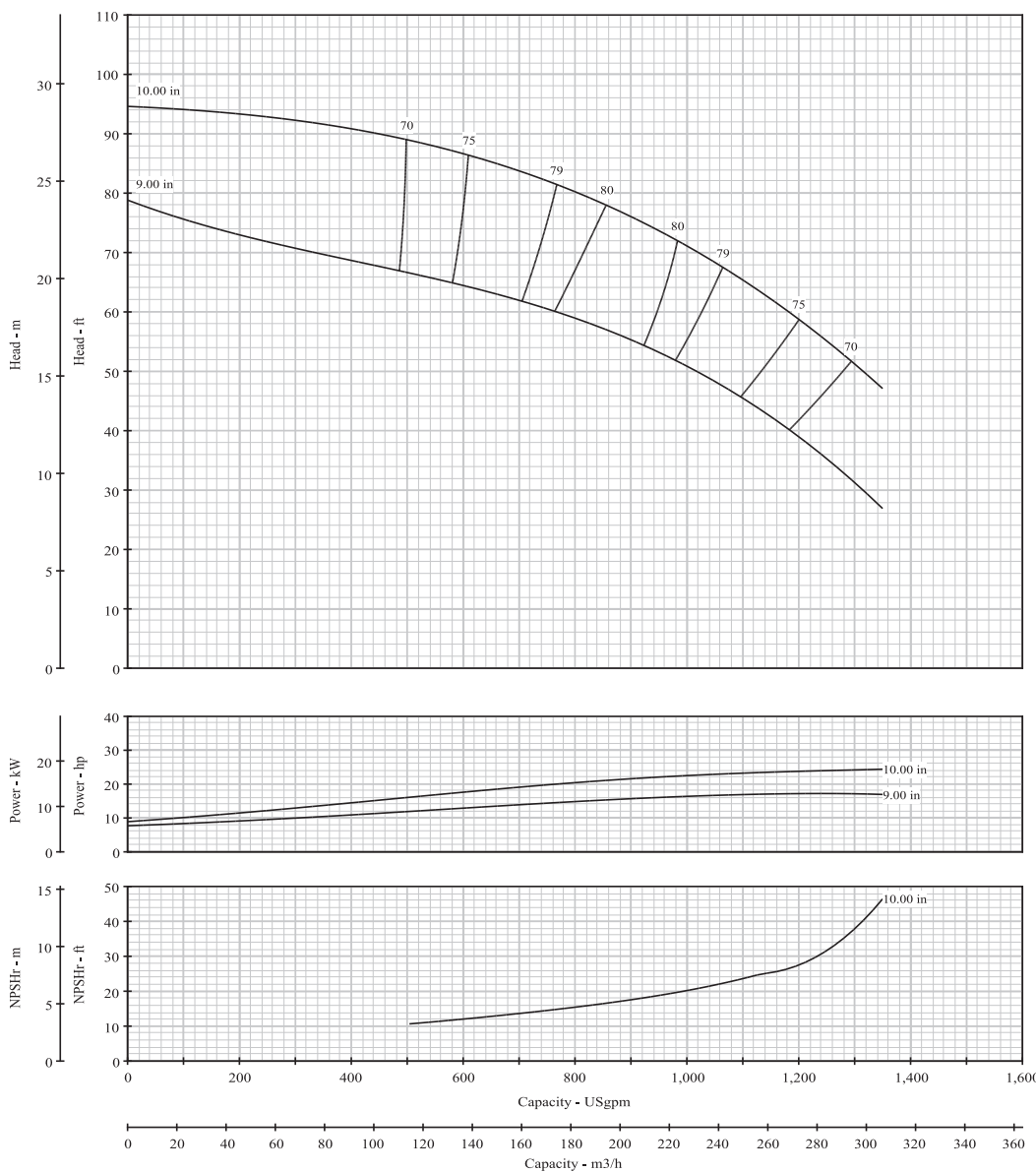

Maximum Operation Speed - RPM	1800	Maximum Sphere Size - inch	0.63
Pump Shaft Diameter - inch	1.687	Thrust Factor - Kt	7.44
Bowl Weight, 1st Stg W/L - lbs	183	WR2	0.83
Bowl Weight, 1st Stg O/L - lbs	230	Running Position (Above Seat) - inch	0.200
Bowl Weight, Ea. Add Stage - lbs	81	Submergence - inch	31
Allowable Shaft Stretch - inch	1.47	Max Bowl Brg Clearance - in. dia	0.014
Std Max Working Pressure - PSI	400	Max Wear Ring Clearance - in. dia	0.015
Optional Max Working Pressure - PSI	700	Max Bowl O.D. - inch	11.75
Impeller Eye Area - Sq. In	20.9	Suction Bell O.D. - inch	13
Rotor Weight 1st/add stages - lbs	24	Standard Max Number Stages	10
Additional Length Per Stage - inch	9.25	Optional Max Number Stages	17
Discharge Thread Column - inch	8 or 10	Suction Threads NPT - inch	8 or 10

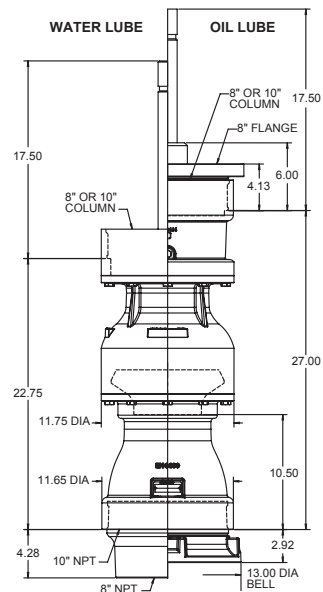

BERKELEY®

VERTICAL LINESHAFT TURBINES

No. Stages	Eff.
1	-2
2	-1
3	0
4	0

12VT900K SEMI-OPEN IMPELLER 1770 R.P.M.

SINGLE STAGE LAB PERFORMANCE WITH STANDARD MATERIALS. EFFICIENCY SHOWN FOR 4 OR MORE STAGES. HORSE POWER SHOWN FOR ONE STAGE BASED ON 4 STAGE EFFICIENCY. CORRECTIONS SHOULD BE MADE FOR STAGES AND MATERIAL

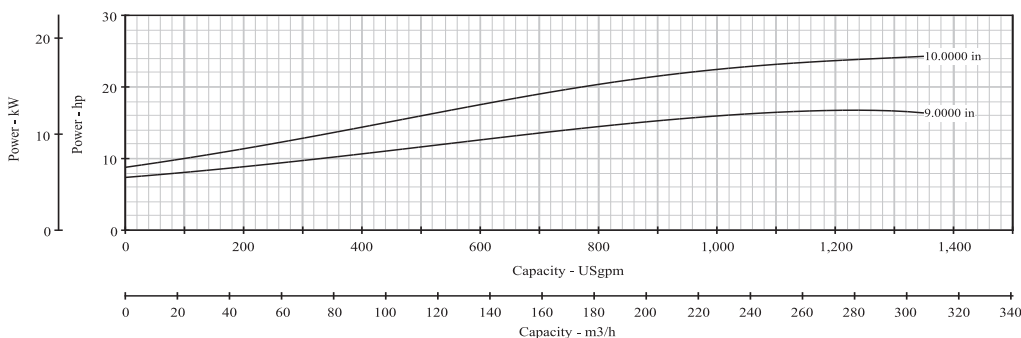
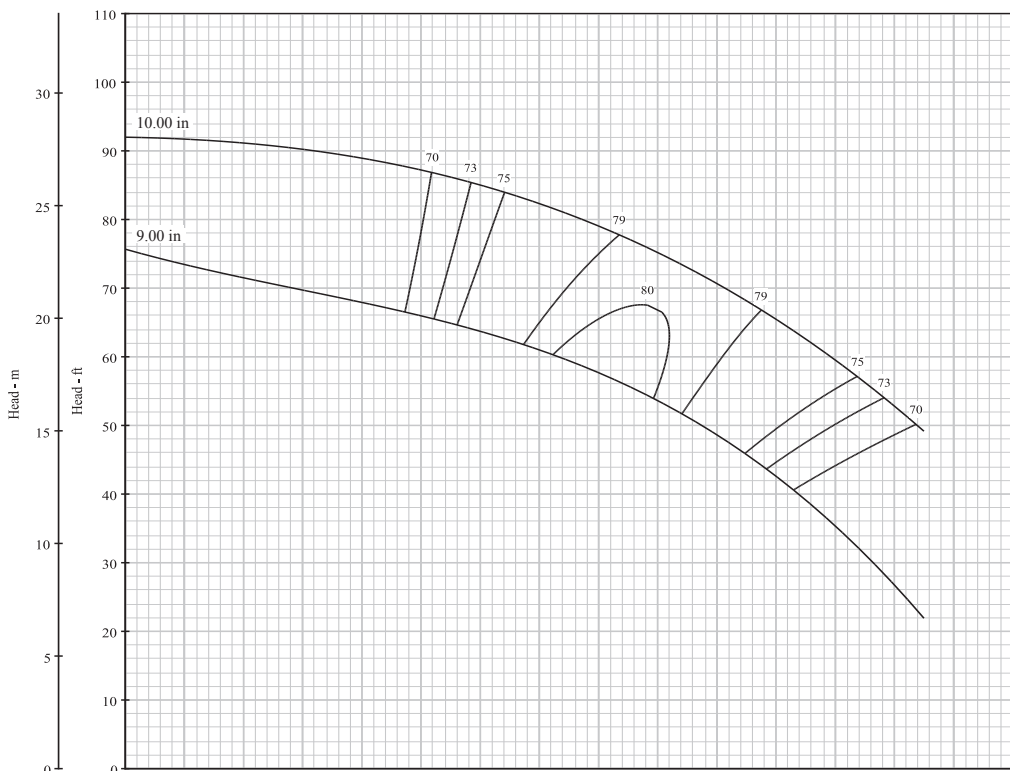

Maximum Operation Speed - RPM	1800	Maximum Sphere Size - inch	0.63
Pump Shaft Diameter - inch	1.687	Thrust Factor - Kt	11.58
Bowl Weight, 1st Stg W/L - lbs	183	WR ²	0.37
Bowl Weight, 1st Stg O/L - lbs	230	Running Position (Above Seat) - inch	0.015
Bowl Weight, Ea. Add Stage - lbs	81	Submergence - inch	33
Allowable Shaft Stretch - inch	1.47	Max Bowl Brg Clearance - in. dia	0.014
Std Max Working Pressure - PSI	400	Max Wear Ring Clearance - in. dia	N/A
Optional Max Working Pressure - PSI	0	Max Bowl O.D. - inch	11.75
Impeller Eye Area - Sq. In	20.9	Suction Bell O.D. - inch	13
Rotor Weight 1st/add stages - lbs	18.7	Standard Max Number Stages	10
Additional Length Per Stage - inch	9.25	Optional Max Number Stages	0
Discharge Thread Column - inch	8 or 10	Suction Threads NPT - inch	8 or 10

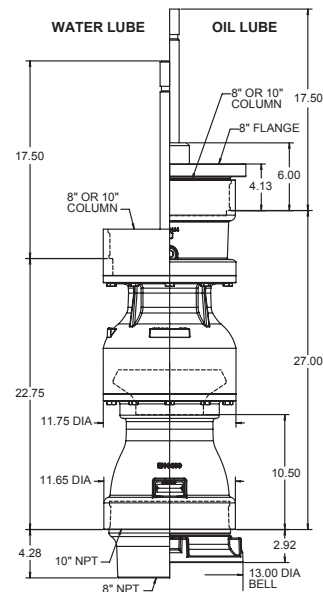

293 WRIGHT STREET, DELAVAN, WI 53115 WWW.BERKELEYPUMPS.COM
PH: 888-237-5353 ORDERS FAX: 800-321-8793

Because we are continuously improving our products and services, Pentair reserves the right to change specifications without prior notice.

B11731BK (08/10/16) © 2016 Pentair plc. All Rights Reserved.