



PENTEK
Pentair Water

293 Wright Street, Delavan, WI 53115
Phone: 866-9 PENTEK (866-973-6835)
Fax: 800-426-9446
www.pumps.com

OWNER'S MANUAL

PENTEK INTELLIDRIVE™

PID10, PID20, PID50

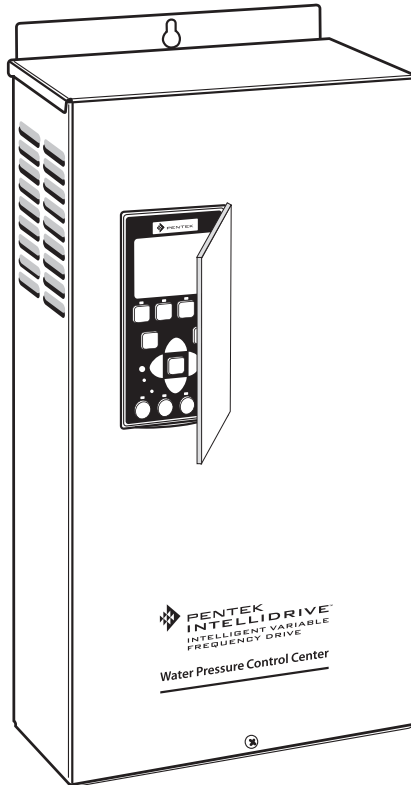

Installation/Operation/Parts

*For further operating, installation,
or maintenance assistance call:*

**866-9PENTEK
(866-973-6835)**

Important Safety Instructions

SAVE THESE INSTRUCTIONS - This manual contains important instructions that should be followed during installation, operation, and maintenance of the PENTEK INTELLIDRIVE Variable Frequency Drive (VFD).

⚠ This is the safety alert symbol. When you see this symbol on your PENTEK INTELLIDRIVE or in this manual, look for one of the following signal words and be alert to the potential for personal injury!

⚠ DANGER indicates a hazard which, if not avoided, *will* result in death or serious injury.

⚠ WARNING indicates a hazard which, if not avoided, *could* result in death or serious injury.

⚠ CAUTION indicates a hazard which, if not avoided, *could* result in minor or moderate injury.

NOTICE addresses practices not related to personal injury.

Carefully read and follow all safety instructions in this manual and on the PENTEK INTELLIDRIVE.

Keep safety labels in good condition. Replace missing or damaged safety labels.

⚠ WARNING Risk of high-voltage electrical shock from EMI/RFI filter inside drive. Can shock, burn or kill if the front cover of the PENTEK INTELLIDRIVE is open or removed while power is connected to the Drive or the Drive is running. The front cover of the Drive must be closed during operation.

- Make all wiring connections, then close and fasten the cover before turning on power to drive.
- **NEVER** open the box when power is connected to Drive.
- Before doing any service or maintenance inside Drive or when connecting or disconnecting any wires inside Drive:
 1. DISCONNECT power.
 2. WAIT 5 minutes for retained voltage to discharge.
 3. Open box.
- Before starting any wiring or inspection procedures, check for residual voltage with a voltage tester.
- **NEVER** connect power wiring to Drive before mounting the box.
- **NEVER** handle or service Drive with wet or damp hands. Always make sure hands are dry before working on Drive.
- **NEVER** reach into or change the cooling fan while power is applied to Drive.
- **NEVER** touch the printed circuit board when power is applied to Drive.

⚠ WARNING Risk of fire. Can cause severe injury, property damage or death if installed with incorrect or inadequate circuit breaker protection. To ensure protection in the event of an internal fault in the PENTEK INTELLIDRIVE, install the Drive on an independent branch circuit protected by a circuit breaker (see Table 2 for circuit-breaker sizing), with no other appliances on the circuit.

⚠ CAUTION Risk of burns. The Drive can become hot during normal operation. Allow it to cool for 5 minutes after shut-down and before handling it to avoid burns.

NOTICE To avoid damage to Drive or problems with Drive:

- Connect output cables to **3-wire** and **3-phase** submersible motors as follows:
 - Red to R, Yellow to Y, Black to B.
 - Any other order will reverse the motor rotation and may damage the motor.
- Connect output cables to **2-wire 1-phase** submersible motors as follows:
 - Connect to Y and B only.
 - Connect Ground to green screw.
- Above ground 3-phase motors may have different lead colors. Generally connect output leads as follows:
 - R to L1, Y to L2, B to L3.
 - Verify rotation after startup.
- Do not modify equipment.
- Do not use power factor correction capacitors as they will damage both motor and PENTEK INTELLIDRIVE.
- Do not remove any parts unless instructed to do so in Owner's Manual.
- Do not use a magnetic contactor on Drive for frequent starting/stopping.
- Do not install or operate Drive if it is damaged or parts are missing.
- Before starting Drive that has been in storage, always inspect it and test operation.
- Do not carry out a megger (insulation resistance) test on the control circuit of the Drive.
- Do not allow loose foreign objects which can conduct electricity (such as screws and metal fragments) inside Drive box at any time. Do not allow flammable substances (such as oil) inside Drive box at any time.
- Ground Drive according to the requirements of the National Electrical Code Section 250, IEC 536 Class 1, or the Canadian Electrical Code (as applicable), and any other codes and ordinances that apply.
- All installation, service work, and inspections must be done by qualified electrician.

Safety 2
 Owner's Information. 3
 Description 4-5
 Installation 6-10
 Initial Startup 11-12
 Programming 13-16
 I/O Connections 17-18
 Additional Information 19
 Troubleshooting 20-22
 Warranty 23

⚠ WARNING

EMI/RFI Filter



Risk of electric shock. Can shock, burn or kill.

- Drive's internal components retain high voltage for up to 5 minutes after input power is disconnected.
- EMI/RFI Filter carries high voltage when pump is running.
- Disconnect power and wait 5 minutes before opening PENTEK INTELLIDRIVE cover.

Owner's Information

PENTEK INTELLIDRIVE Model No. _____

PENTEK INTELLIDRIVE Serial No. _____

Pump Model No. _____

Pump Serial No. _____

Motor Model No. _____

Motor Service Factor Amps _____

Pressure Tank Model No. _____

Pressure Tank Serial No. _____

Dealer/Installer: _____

Installer Phone No. _____

Date of Installation _____

Wire Lengths in Feet (Meters):
 Circuit Breaker to Drive _____

PENTEK INTELLIDRIVE to Motor _____

Supply Voltage _____

Note to Installer: Record the data listed above for future reference. Give manual to end user or attach to PENTEK INTELLIDRIVE when installation is complete.

Specifications/Ratings

Input Voltage 1-Phase 230VAC Nominal (190–265VAC)
 Input Frequency 50/60Hz
 Ambient Temperature Range -4 to 122 °F (-20° to 50 °C)
 Output Connections 3-Phase, 3-Wire/1-Phase or
 1-Phase/2-Wire
 Max Motor Cable Length..... 1,000 feet
 Enclosure..... Type 1

Each carton contains:

- PENTEK INTELLIDRIVE Variable Frequency Drive
- Pressure Transducer
- 10' Pressure Transducer Cable
- Quick Start Guide
- Owner's Manual

Table 1 - Specifications

Model	Max HP	Input Phase	Motor Operation	Max Amps
PID10	1.0	1	2-wire, 3-wire,	10.5
PID20	2.0		3-phase	13.5
PID50	5.0	1	3-phase	18.0

The PENTEK INTELLIDRIVE is specifically designed to operate 4" submersible pumps and 3-phase above ground pumps in water well and residential booster applications. Each Drive is rated for maximum output amp rating. Any use of Drive outside of intended design parameters will void warranty. If Drive is used with above ground motors not rated for a Variable Frequency Drive, maximize motor life by limiting lead length to 25 ft. Refer to pump Owner's Manual and the National Electrical Code for proper wire size.

PENTEK INTELLIDRIVE Model Number Structure

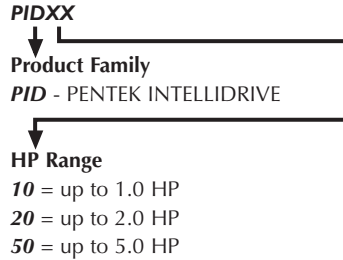

The PID10 and PID20 will operate a 1-phase 2-wire, 1-phase 3-wire, and 3-phase motor up to the HP range of the Drive. The PID50 only operates a 3-phase motor up to 5 HP.

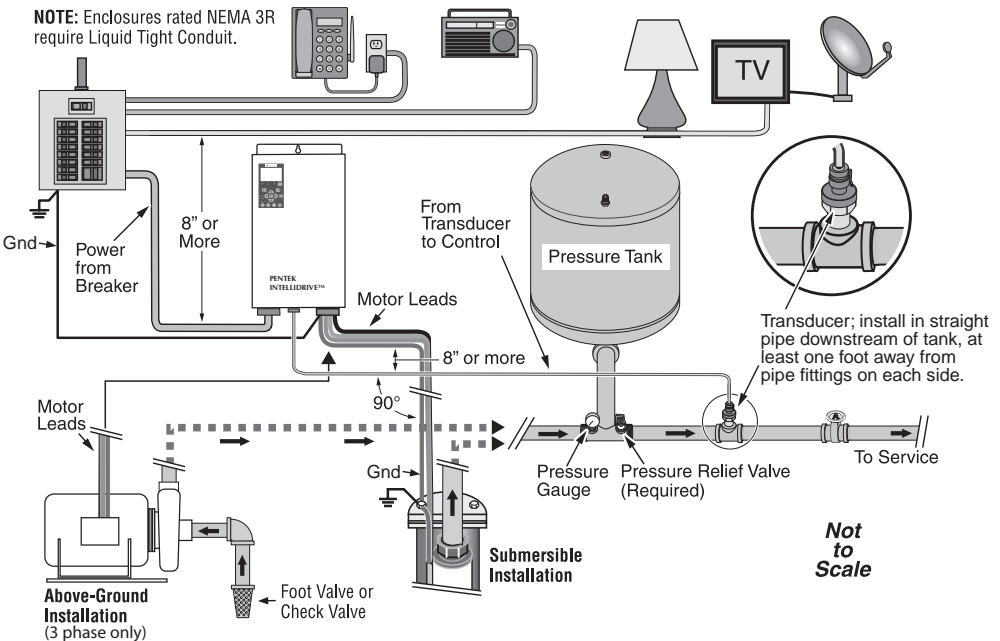

Figure 1 - A typical residential installation layout

Transducer

The PENTEK INTELLIDRIVE uses a 4-20mA, 0-100PSI pressure transducer to control motor speed (max is 300 PSI transducer).

The transducer (see Figure 1) senses pressure in the pipe and converts it to an electrical signal. The Drive senses and processes the signal in the PID (Proportional, Integration, Derivative) control. When operating in AUTOSTART mode, the Drive increases and decreases the speed of the pump motor as needed to maintain constant pressure in the piping system.

Keypad

The keypad programs the Drive, monitors the status of the pump, and displays faults if they occur. Each button has a unique function, as described in Figure 2. The LCD display shows a text display of the status of the Drive's operation. Other LEDs light up to indicate when certain buttons are pressed or certain events occur.

Fan

The Drive uses a thermostatically controlled internal fan which operates automatically when necessary to cool the Drive components.

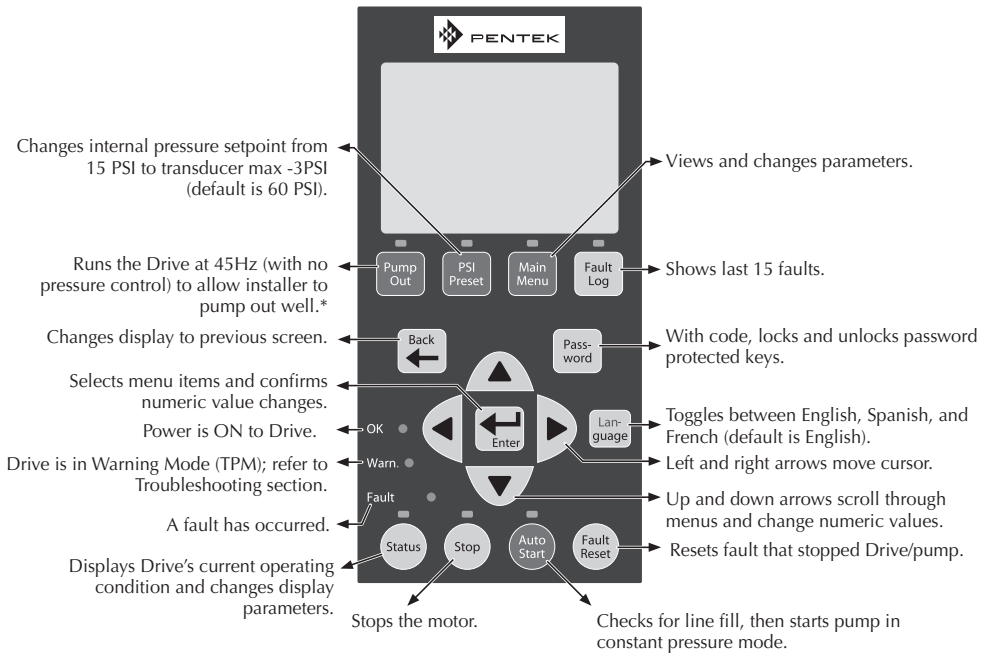

Figure 2 - PENTEK INTELLIDRIVE keypad functions

Table 2 - Circuit Breaker and Wire Sizes.

Motor	Drive Model	Volts	Motor HP	Wire Size*		Circuit Breaker**	Generator (kVA)***
				Input	Output		
2-wire	PID10	230	1/2	14	14	15	2.2
			3/4	12	12		3.1
			1			20	4.4
	PID20		1-1/2	10	10	25	5.3
3-wire	PID10		1/2	14	14	15	2.3
			3/4	12	12		3.0
			1				3.5
	PID20		1-1/2	10	10	25	5.3
			2				5.8
3 phase	PID10		1/2	14	14	15	2.1
			3/4				2.8
			1	12			3.4
	PID20	1-1/2	10	12	20	4.4	
		2			25	5.5	
		3			10	30	7.3
	PID50	5	6	8	50	12.6	

* AWG will change depending on the length of wire. See Tables 3-6.

** With properly-sized circuit breakers, the Drive is protected from short circuit on the input and the output. There is no risk of fire or electrical shock due to a short circuit. The Drive has NEC Class 10 overload protection.

*** Minimum 240V generator size.

NOTICE Information in Tables 3-6 applies ONLY to PENTEK® motors. For other motors, refer to motor manufacturer specifications for wire sizing.

Table 3 - Service Entrance to Drive - 1 Phase, 2-Wire 40°C Ambient, and 5 percent Voltage Drop, 60C and 75C Insulation (copper only).

Motor Rating			Maximum Cable Length in feet (M)					
Volts	HP	SFA	14 AWG	12 AWG	10 AWG	8 AWG	6 AWG	4AWG
230	1/2	4.7	447 (136)	712 (217)	1000 (305)	-	-	-
	3/4	6.2	341(104)	542 (165)	864 (263)	1000 (305)		
	1	8.1	261(79)	415 (126)	661 (202)	1000 (305)		
	1 1/2	10.4	203 (62)	323 (98)	515 (157)	816 (249)	1000 (305)	
	2	12.2	173 (53)	275 (84)	439 (134)	696 (212)	1000 (305)	
	3	10.1	209 (64)	333 (101)	530 (162)	840 (256)	1000 (305)	
	5	17.5	121(37)	192 (59)	306 (93)	485 (148)	754 (230)	

Table 4 - AWG Wire Sizing, Drive to 1-Phase, 2-Wire Motor, 40°C Ambient, and 5 percent Voltage Drop, 60C and 75C Insulation (copper only).

Motor P/N	Motor Rating			Maximum Cable Length in feet (M)				
	Volts	HP	SFA	14 AWG	12 AWG	10 AWG	8 AWG	6 AWG
P42B0005A2-01	230	1/2	4.7	447 (136)	712 (217)	1000 (305)	–	–
P42B0007A2-01		3/4	6.2	341 (104)	542 (165)	864 (263)	1000 (305)	
P42B0010A2-01		1	8.1	261 (80)	415 (126)	661 (201)	1000 (305)	
P42B0015A2-01		1 1/2	10.4	203 (62)	323 (98)	515 (157)	816 (249)	1000 (305)

Table 5 - AWG Wire Sizing, Drive to 3-Wire, 1-Phase Motor, 40°C Ambient, and 5 percent Voltage Drop, 60C and 75C Insulation (copper only).

Motor P/N	Motor Rating			Maximum Cable Length in feet (M)				
	Volts	HP	SFA	14 AWG	12 AWG	10 AWG	8 AWG	6 AWG
P43B0005A2-01	230	1/2	4.8	440 (134)	700 (213)	1000 (305)	–	–
P43B0007A2-01		3/4	6	352 (107)	560 (171)	893 (272)	1000 (305)	
P43B0010A2-01		1	7.3	289 (88)	460 (140)	734 (224)	1000 (305)	
P43B0015A2-01		1 1/2	10.9	194 (59)	308 (94)	492 (150)	778 (237)	1000 (305)
P43B0020A2-01		2	12.2	173 (53)	275 (84)	439 (134)	696 (212)	1000 (305)

Table 6 - AWG Wire Sizing, Drive to 3-Phase Motor, 40°C Ambient, and 5 percent Voltage Drop, 60C and 75C Insulation (copper only).

Motor P/N	Motor Rating			Maximum Cable Length in feet (M)					4 AWG*
	Volts	HP	SFA	14 AWG	12 AWG	10 AWG	8 AWG	6 AWG	
P43B0005A3	230	1/2	2.9	728 (222)	1000 (305)	–	–	–	–
P43B0007A3		3/4	3.9	541 (165)	861 (262)	1000 (305)			
P43B0010A3		1	4.7	449 (137)	715 (218)	1000 (305)			
P43B0015A3		1 1/2	6.1	346 (105)	551 (168)	878 (268)	1000 (305)		
P43B0020A3		2	7.6	278 (85)	442 (135)	705 (215)	1000 (305)		
P43B0030A3		3	10.1	209 (64)	333 (101)	530 (162)	840 (256)	1000 (305)	
P43B0050A3		5	17.5			306 (93)	485 (148)	754 (230)	

*Installations that require wire gauge larger than 6 AWG will require an external junction box. Run 6 AWG wire from the Drive into the junction box, then make external connections with wire nuts to appropriately sized wire.

Mounting the Drive

To mount the Drive as shown in Figure 6, follow this procedure:

1. First, remove the cover by backing out screw at bottom of front cover.
2. Push on backplate with thumbs while pulling the cover toward you with index fingers, creating a gap. See Figures 3 and 4.



Figure 3 - Separate cover and backplate

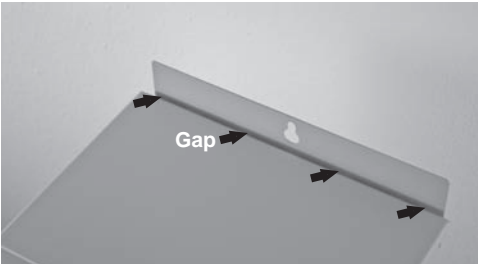

Figure 4 - Gap between cover and backplate

3. Pull bottom of cover towards you; lift up on cover and remove. See Figure 5.



Figure 5 - Pull out bottom of cover

4. With the cover removed, permanently mount the Drive using the top slotted hole, plus either the three bottom holes (for flat surface mounting) or the center bottom hole (for attaching to a post or stud). See Figure 6.

5. Ensure the Drive's ventilation holes are not blocked and there is enough space around it to allow free air flow (minimum 3" clearance on top, bottom, and sides). See Figure 6. Once the Drive is mounted, electrical wiring can be connected.

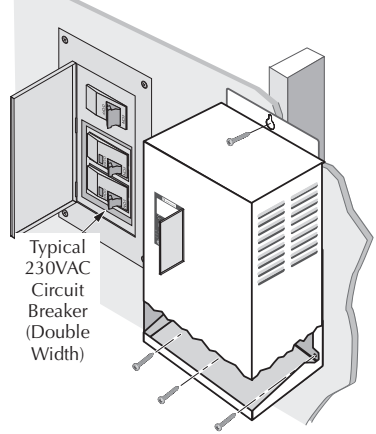

Figure 6 - Attaching Drive to wall

6. To reattach the Drive cover, hook the top of it on backplate (be sure to leave a gap). Lower bottom of cover into place. Push cover evenly against backplate, eliminating the gap. See Figure 7.



Figure 7 - Reattaching Drive cover

7. Replace screw at bottom of front cover.

Wiring

To allow for ease of wiring, the enclosure wiring area is free of electronics other than the terminals. Conduit holes and knockouts are located so that the wire can be fed straight through to the connectors, with minimal bending. The terminals accept 6-14 AWG wire.

Installations that require larger wire gauge than 6 AWG will require an external junction box. Run 6 AWG wire from the Drive into the junction box, then make external connections with wire nuts to appropriately sized wire.

NOTICE For convenience in wiring, the input and motor terminals unplug from the box. Pull them down to remove them for ease of access, as shown in Figure 9.

Verify that the terminal connectors are completely seated when you replace them. It is best practice

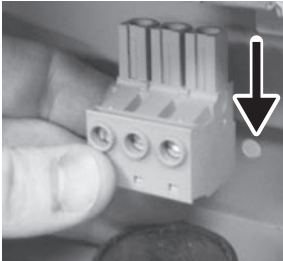
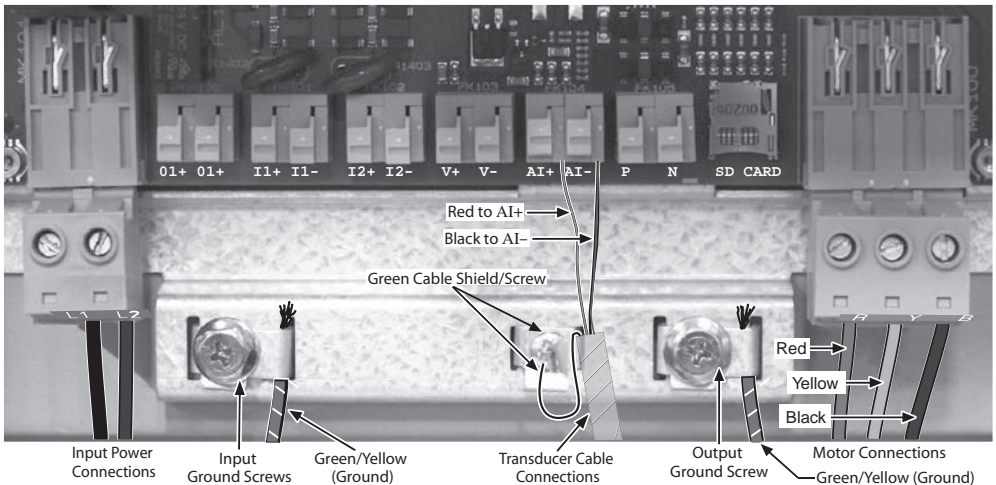

Figure 8 - Pull input and motor terminals down to remove, making wiring easier.



Submersible Motor: 3-Ph./ 3-W. 1-Ph., follow colors as above.
Submersible Motor: 1-Ph./ 2-W., connect to Y and B, any order.
Above-Ground Motors: L1 to R, L2 to Y, L3 to B; verify rotation.

Figure 9 - Basic Wiring Connections for Startup

to connect all output wires (larger wire gauge) first, then all input wires.

Pump Connections

If the PENTEK INTELLIDRIVE is used with above ground motors not rated for Variable Frequency Drive use, maximize motor life by limiting lead length to 25 ft. Refer to the pump owner’s manual, the National Electrical Code, and local codes for proper wire size.

The output of the Drive is single phase (2-wire or 3-wire) or 3-phase, depending on motor selection during startup.

The output power terminals (motor wire connections) are located on the lower right side of the Drive and are labeled R (Red), Y (Yellow), and B (Black). See Tables 2 through 6 for suggested wire sizes.

Feed the motor cable through the 3/4” conduit hole on the bottom right side and into the appropriate terminals. If the wire is large enough to require a larger conduit hole, remove the 1-1/4” knockout and use the appropriate conduit connections. Attach the motor ground wire to the grounding screw, located to the upper right of the terminal block. Attach the motor power wires to the terminals as shown in Figure 9.

Pressure Tank Recommendations

Minimum tank size is two gallons. Use a pre-charged pressure tank with Drive, as shown in Table 6. The tank size must equal at least 20 percent of the pump's rated flow in gallons per minute (GPM), but cannot be less than two gallons capacity. For example, a pump rated at 7 GPM would require a tank of two gallons capacity or larger. A pump rated at 50 GPM would require a 10 gallon tank or larger. Tanks larger than 10 gallons can be used, but may require adjustment of *Wake Delay* parameter.

Table 7 - Control Pressure Set Point and Tank Pre-Charge Pressure Values (PSI).

Pressure Point Setting (PSI)	Precharge Pressure (PSI)	Pressure Point Setting (PSI)	Precharge Pressure (PSI)
25	18	65	46
30	21	70	49
35	25	75	53
40	28	80	56
45	32	85	60
50	35	90	63
55	39	95	67
60 (Default)	42	-	

NOTICE Set pressure tank's pre-charge to 70 percent of the system operating pressure. When using an external set point as well as an internal set point, pre-charge tank to 70 percent of the lower setpoint of the two. Some applications may require a different percentage when determining the setpoint.

Transducer Connections

A 0-100 PSI 4-20 mA transducer is provided with Drive. Install the transducer downstream of tank, as shown in Figure 1. Install transducer in a tee in a straight section of pipe with at least 1 foot of straight pipe on each side of the tee (i.e., all fittings must be at least 1 foot away from transducer).

Feed transducer cable through the open 1/2" conduit hole on bottom of the Drive enclosure.

As shown in Figure 5, connect the red wire of the transducer cable to AI+, connect black wire to AI-, and connect the green cable shield to the metal cable shield screw.

To connect the transducer wires:

1. Strip wire 1/2 inch
2. Push spring terminal up with finger or slotted screwdriver
3. Insert wires from bottom
4. Release spring terminal

Input Power Connections

The input power terminals are located on the lower left side and are marked L1 and L2 (see Figure 9). There is a ground screw for the input ground wire to the right of the connector (torque to 10 lbs in). Feed wire through the 3/4" conduit hole on the bottom left side and into appropriate terminals. If wire is large enough to require a larger conduit hole, remove the 1-1/4" knockout and use appropriate conduit connections.

To determine the correct wire sizes for installation, see Tables 2 through 6.

NOTICE The PENTEK INTELLIDRIVE only accepts 230V single phase input power. If incoming power does not match this, have a qualified electrician alter supply voltage to 230V/1Ph before connecting it to the Drive.

Initial Startup and Programming Procedures

Ensure that the cover is installed before operating the PENTEK INTELLIDRIVE.

Most installations will only require the initial startup settings. However, the installer may need to set additional parameters. Information about accessing all parameters, explanations of their functions, and procedures for changing parameter values, will be found later in this section.

1. **Program the Drive:** Apply power to the PENTEK INTELLIDRIVE. *Setup Guide* will appear in the display. Follow keypress sequence shown in Figure 10.

NOTICE If *Setup Guide* does not appear, refer to *Drive Reset Procedure*, Figure 20.

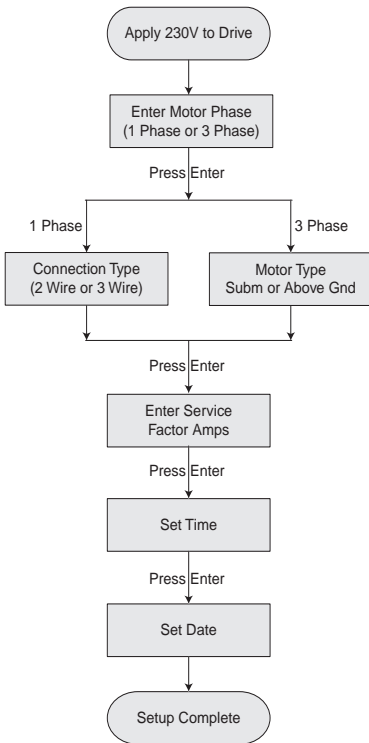

Figure 10 - Drive Setup Guide.

Service Factor Amps

To maximize pump performance, be sure to enter the correct Service Factor Amps (SF Amps) in the PENTEK INTELLIDRIVE.

- Entering SF Amps **higher** than the motor rating lets the Drive supply more amps to the motor than the motor is designed for and may allow the motor to overheat (see Table 8).
- Entering SF Amps **lower** than the motor rating limits the output amps to less than the motor is designed for and will reduce the performance of the pump.
- For any 1-Phase 3-Wire motor, the correct Service Factor Amp rating for the Drive is Cap Start/Cap Run amps (see Table 8). This may not match the motor nameplate, which (for a Single Phase, 3-Wire motor) will generally be Cap Start/ Induction Run Amps.
- For any 3-Phase or 1 Phase, 2-Wire motor, use the motor nameplate Service Factor Amp rating.

NOTICE PENTEK® submersible motors may differ from motors of the same horsepower from other manufacturers. **For 1-Phase, 3-Wire motors from all other submersible motor manufacturers, enter the motor manufacturer's CS/CR service factor amps for your motor.** For 3-Phase or 2-Wire 1-Phase motors, use the motor nameplate amp value. Also see *Retro Fit Applications*.

2. **Select 80 Hz Operation**, if necessary (See *60 Hz to 80 Hz Operation* for more information):
 - A. Press *MAIN MENU* button.
 - B. Follow the keypress sequence shown in Figure 11.

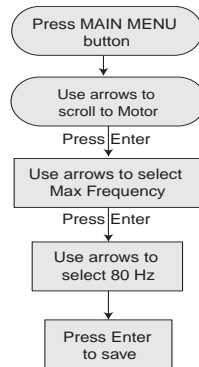

Figure 11 - Select 80 Hz (3-phase operation only).

3. **Pump out well** (if necessary):
 Direct pump's discharge to appropriate location not connected to system and press *Pump Out*. The pump will run at 45 Hz.
 Adjust frequency as appropriate:
 - A. Press *ENTER*
 - B. Change frequency value

Table 8 - PENTEK Motor Service Factor Amps

Motor Type	PENTEK Part Number	Rating @ 230V	Service Factor Amps
		HP	
2-Wire	P42B0005A2-01	1/2	4.7
	P42B0007A2-01	3/4	6.2
	P42B0010A2-01	1	8.1
	P42B0015A2-01	1-1/2	10.4
	P42B0005A2	1/2	4.7
	P42B0007A2	3/4	6.4
	P42B0010A2	1	9.1
	P42B0015A2	1-1/2	11.0
CS/CR 3-Wire	P43B0005A2-01	1/2	4.8
	P43B0007A2-01	3/4	6.0
	P43B0010A2-01	1	7.3
	P43B0015A2-01	1-1/2	10.9
	P43B0005A2	1/2	4.9
	P43B0007A2	3/4	6.3
	P43B0010A2	1	7.2
	P43B0015A2	1-1/2	11.1
3-Phase	P43B0020A2	2	12.2
	P43B0005A3	1/2	2.9
	P43B0007A3	3/4	3.9
	P43B0010A3	1	4.7
	P43B0015A3	1-1/2	6.1
	P43B0020A3	2	7.6
	P43B0030A3	3	10.1
P43B0050A3	5	17.5	

NOTICE Above ground pumps should run at 60 Hz for this step (until pump is primed). Then adjust frequency as necessary.

- C. Press *ENTER* again.
 Run the Drive in this mode until the well discharge runs clear, then press *STOP* button to stop Drive.

⚠ WARNING Risk of explosion. In *Pump Out* mode, pump runs at a constant speed, which can cause very high pressure if flow is restricted.

4. **Verify installation:** Make sure that the system has properly-sized, pressure-relief valve and pressure tank.
 Make sure pressure tank's precharge is correct. See Table 7.
 Make sure pump discharge is connected to system.
5. **System Start:**
 - A. Open valves at the ends of lines so that air will escape during pressurization.
 - B. Press *Auto Start*; close valves at the ends of lines after all air has escaped.
 - C. The system goes into *Constant Pressure Operation* as soon as the transducer registers the *Dry Run Sensitivity* parameter (default is 10 PSI). If system pressure does not reach that PSI value within 3 minutes, the Drive will stop. Press *Auto Start* again to restart line fill. If longer priming or line fill time is required, adjust *Fill Time* parameter. See Table 9.

Changing a Parameter Value

This procedure works for ANY parameter.

- A. Press *MAIN MENU* button.
- B. Follow the keypress sequence shown in Figure 12:

A shorthand way to remember this is:

- Press *ENTER* to change a value
- Press *ENTER* again to save it
- If new value is not saved, any screen change will result in the loss of the new value.

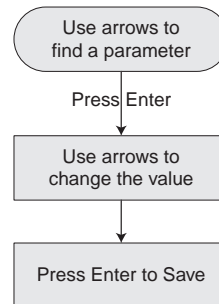

Figure 12 - Changing parameter value.

Table 9 lists all available commands and parameters for the PENTEK INTELLIDRIVE.

60 Hz to 80 Hz Operation

When installing the PENTEK INTELLIDRIVE with a motor and liquid end of the same HP rating, operate it at 60 Hz (the default value). The Drive can be operated at frequencies of up to 80 Hz when the installation uses a 3-phase motor 2 times the size of the pump. For example, a 1 HP pump with a 2 HP 3-phase motor. This combination will equal the performance of a conventional 2 HP pump.

Press *Main Menu* and follow the keypress sequence shown in Figure 7. Be sure to press *ENTER* to save the new *Max Frequency* selected. The Drive will now use the new value selected.

NOTICE The Drive will not allow the output amps to go above the Service Factor Amps selected on the keypad. Because of this, some 80 Hz operations may be limited. This protects the motor and may be a common occurrence in a 80Hz operation.

Keypad Lock - Password

The password locks or unlocks the blue buttons on keypad. All PENTEK INTELLIDRIVE units are shipped from factory with the default password 7777. It can be changed to any other 1 to 4 digit number. To reset password to a unique password for unit, unlock keypad (see below) and follow the keypress sequence shown in Figure 8 to make the change.

If installer does not press the password button, then the keypad will automatically lock 60 minutes after the Drive is powered up. The time out period is adjustable (see Table 9).

To unlock keypad press *Password*, use directional arrows to select numeric code and press *ENTER*.

NOTICE For more detailed information on keypad functions, see Figure 2.

Pump Out Operation

Press *Pump Out*. The Drive will start pump in a constant speed mode (default 45 Hz). The pump will run until *STOP* or *Auto Start* are pushed. If speed change is necessary, follow keypress sequence shown in Figure 8 to change parameter as desired.

Setting the Pressure

NOTICE Default pressure setting is 60 PSI. If this value is changed, adjust tank pressure accordingly (see Table 7).

There are three ways to change the pressure setpoint:

1. While running the pump
 - Follow keypress sequence shown in Figure 13 to make desired change. This parameter allows either *Internal* or *External Setpoint* to be changed, depending on which one is referenced at the time the change is made.

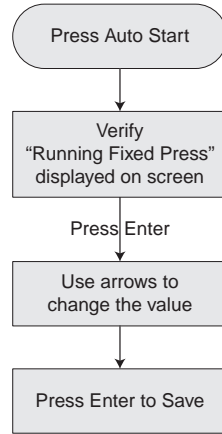

Figure 13 - Change PSI Setpoint while running pump.

2. Via the PSI Preset

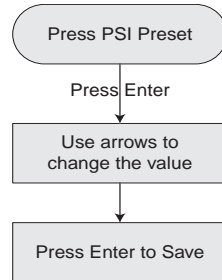

Figure 14 - Change PSI Setpoint using PSI Preset.

3. Via the *Main Menu* (*Main Menu/Settings/Setpoint/Internal Setpoint*)

Table 9 lists all available commands and parameters for the PENTEK INTELLIDRIVE.

Table 9 - Main Menu and Parameters

Menu Settings	Parameter	Unit of Measure	Value			Description
			Default	Min.	Max.	
Time/Date	Hour Format	Hours	12Hr	12Hr	24Hr	Selects 12 or 24 hour time scale.
	Time	mm:ss	1:00 AM	1	24	Sets current time. Used for time stamp in fault log.
	Date	MM/DD/YYYY	1/1/12	-	-	Sets current date. Used for date stamp in fault log.
PID Control	Proportional Gain	-	2500	0	10000	Sets the PID controller gain. Used in conjunction with all <i>PID Control</i> parameters to control how fast or slow the Drive reacts to pressure changes.
	Integration Time	Milliseconds	500 ms	20 ms	65000 ms	Sets the PID controller integration time. Used in conjunction with all <i>PID Control</i> parameters to control how fast or slow Drive reacts to pressure changes.
	Derivation Time	Milliseconds	60 ms	0 ms	10000 ms	Sets PID controller derivation time. Used in conjunction with all <i>PID Control</i> parameters to control how fast or slow Drive reacts to pressure changes.
	Derivative Limit	-	120	0	2000	Sets derivative filter time constant for PID controller.
Sleep	Boost Differential	PSI	3 PSI	3 PSI	10 PSI	First part of <i>Boost Process</i> . Pressure boost that happens before it goes to <i>Wake Delay</i> .
	Boost Delay	MM:SS	1 Min	30 Sec	5 Min	The time Drive takes to start <i>Boost Process</i> after system has stabilized.
	Wake Up Differential	PSI	5 PSI	5 PSI	15 PSI	Pressure amount below setpoint that wakes up Drive.
	Wake Delay	MM:SS	15 Sec	3 Sec	2 Min	Second part of the <i>Boost Process</i> . The time it takes to ramp down pressure during the <i>Boost Process</i> .
Password	Password Time Out	HrHr:mm	1 Hr	1 Min	6 Hr	Amount of time it takes to lock keypad (after last button is pressed).
	Password	-	7777	0000	9999	Password used to unlock keypad.

Table 9 - Continued

Menu Settings	Parameter	Unit of Measure	Value			Description
			Default	Min	Max	
Setpoints	<i>Internal Setpoint</i>	PSI	60 PSI	15 PSI	Max Sensor Value minus 3 PSI.	Main pressure setpoint used. Sets main system operational pressure. This parameter is accessed here, through PSI Preset button, or by pressing Enter button while in <i>Constant Pressure</i> operation.
	<i>External Setpoint</i>	PSI	40 PSI	15 PSI	Max Sensor Value minus 3 PSI.	Second pressure setpoint. When another pressure setting is desired other than <i>Internal Setpoint</i> . Additional programming needed in I/O section. Requires an external switch or timer to wired to I1 or I2 terminals. It is only active when there is voltage present I1 terminals (see Figure 11)
Sub Menu	Parameter	Unit of Measure	Default	Max	Min	Description
Motor	<i>Motor Phase</i>	-	1	1	3	Selects phase of motor to be operated. An additional sub menu will appear, based on phase selection, to select proper motor type.
	<i>Connection Type</i>	-	3 wire	3 wire	2 wire	Wire type for 1 phase motor operation only. Can only access by first setting <i>Motor Phase</i> parameter to 1 Phase.
	<i>Motor Type</i>	-	Subm	Subm	Above Gnd	Motor type for 3 phase motor operation only. Can only access by first setting <i>Motor Phase</i> parameter to 3 Phase.
	<i>Service Factor Amps</i>	A	00.0 A	00.0 A	Per drive and motor	Service factor amps (max. load) of motor the Drive is operating. Sets maximum allowed amps at output of Drive. See Table 7 for values.
	<i>Min Frequency</i>	Hz	30 Hz	30 Hz	1 below Max Hz	Minimum frequency (speed) motor will run.
	<i>Max Frequency</i>	Hz	60 Hz	1 above Min Hz	80 Hz	Maximum frequency (speed) motor will run. Up to 80Hz is only available on only when <i>Motor Phase</i> is set to 3.
Sensor	<i>Max Sensor Value</i>	PSI	100 PSI	10 PSI	300 PSI	Maximum pressure value of transducer sensor used with Drive. Only change if different transducer is used with Drive, other than 100 PSI max scale.

Table 9 - Continued

Menu or Sub Menu	Parameter	Unit of Measure	Value			Description
			Default	Min	Max	
Ex Runtime	Excessive Runtime Detection	-	Enabled	Disabled	Enabled	Enables or disables <i>Excessive Runtime Detection</i> .
	Excessive Runtime Hours	Hours	24	1	100	Number of hours Drive can run before it faults on <i>Excessive Runtime</i> .
Dry Run	Auto Restart Delay	Minutes	10 Min	3 Min	60 Min	Time Drive waits to restart pump when <i>Dry Run</i> is detected.
	Number of Resets	-	3	0	5	Number of tries Drive attempts to restart pump when <i>Dry Run</i> condition is detected.
	Detection Time	M:SS	15 Sec	5 Sec	10 Min	Time the Drive takes to recognize <i>Dry Run</i> condition.
	Sensitivity	PSI	10	0	300	Pressure value that <i>Dry Run</i> condition is detected at. <i>Dry Run</i> fault will occur if this pressure cannot be met within <i>Detection Time</i> window. Lower pressure = less sensitivity.
	Fill Time	M:SS	1 M	15 S	10 M	Time allowed to fill (prime) pipes during Auto Line Fill process. Relates to <i>Dry Run Sensitivity</i> value. (Time starts after 55 Hz is reached).
I/O	Digital Input 1	-	Unused	-	-	Selects operation of Drive when terminal I1 is used. Select between <i>Unused</i> , <i>Run Enabled</i> , <i>Ext Fault</i> , and <i>Setpoint</i> . The Drive will respond to selected command when voltage is present at I1 terminal.
	Digital Input 2					
	Relay Output	-	Unused	-	-	Selects the operation of Drive when terminal O1 is used. Select between <i>Unused</i> , <i>Run</i> , and <i>Fault</i> . The Drive closes the <i>Relay</i> when <i>Run</i> or <i>Fault</i> is selected.
Over Press	Over Pressure	PSI	80 PSI	15 PSI	97 PSI	Sets <i>Over Pressure Warning</i> value. Change if higher than 80 PSI system pressure is needed.
No Ground	No Ground Detection	-	Enabled	Disabled	Enabled	Selects whether <i>Ground Detection</i> parameter is <i>Enabled</i> or <i>Disabled</i> . If <i>Disabled</i> is selected, it will revert back to <i>Enabled</i> after 72 hours. Warning LED will flash entire time it is <i>Disabled</i> .
Reset	Factory Reset	-	No	No	Yes	Resets all parameters to factory defaults. Displays <i>Setup Guide</i> after it is complete. Software version displayed here. Does not clear fault log.
SW Update	Software Update	-	Disabled	Disabled	Enabled	Used to update software, if necessary.

The I/O terminals are located in the center of the wiring compartment, as shown previously in Figure 9.

The *Digital Input* connections (I1 and I2) are used to control the Drive based on the state of an external device, such as a flow switch, moisture sensor, alternator, or other device. Programming is needed to activate any of these functions (see Table 9).

The *Output Relay* (O1) is used to control an external device based on two states of Drive; either *Running* the pump or *Faulted*. Programming is needed to activate any of these functions (see Table 9).

Cable Installation

Three 1/2" conduit knockouts are provided on the bottom of the Drive enclosure for the I/O wires.

Break out the closest 1/2" knockout and route the wires through. Use a cord grip to prevent the wire from rubbing and causing a short.

NOTICE Never run low voltage I/O wire through the same conduit hole as the 230V input wires or motor wires.

To connect the external wires to the terminals:

1. Strip wire 1/2 inch
2. Push spring terminal up with finger or slotted screwdriver
3. Insert wires from bottom
4. Release spring terminal

Connection Examples

Figures 15-18 show various connection schemes for typical applications. Table 10 describes each I/O terminal, including purpose and rating.

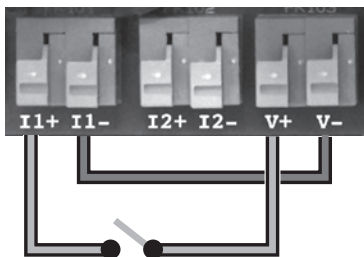

Figure 15 - Example Input with internal 24 volt supply

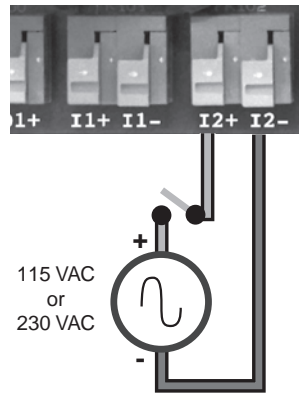

Figure 16 - Example external Input with external supply

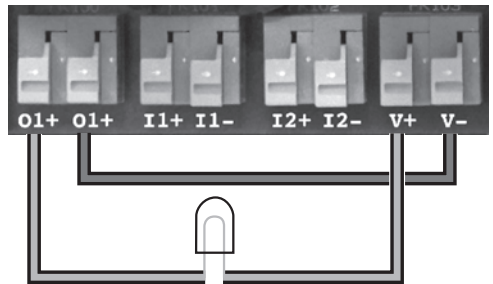

Figure 17 - Example Output relay with internal 24 volt supply

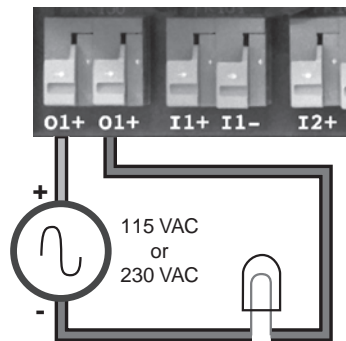

Figure 18 - Example Output with external supply

Table 10 - I/O Function, Connections, Ratings

Label	Function	Connection	Rating
AI+	Positive connection for transducer	Red transducer wire	24 Volt (supplied)
AI-	Negative connection for transducer	Black transducer wire	
V+	Positive side of 24 volt power supply. Used to power external devices.	Positive side of 24V external device, i.e., flow switch, moisture sensor, alternator, etc. Need to complete the circuit with V-. See Figures 11 and 13.	40mA maximum output
V-	Negative side of 24 volt power supply. Used to power external devices.	Typically to I1-, I2-, or O1-. Used with a flow switch, moisture sensor, alternator, etc. Need to complete the circuit with V+. See Figures 11 and 13.	
I1+	Positive (dry contacts) connection of Digital Input 1. Connect when using an external device to control Drive.	From an external device i.e., flow switch, moisture sensor, alternator, etc. Requires complete circuit connection with I1-. See Figures 11 and 12.	Accepts 24VDC and up to 230VAC
I1-	Negative (dry contacts) connection of Digital Input 1. Connect when using an external device to control Drive.	Can be from V- or from the negative side of an external power supply. Requires complete circuit connection with I1+. See Figures 11 and 12.	
I2+	Positive (dry contacts) connection of Digital Input 2. Connect when using an external device to control Drive.	From an external device, i.e., flow switch, moisture sensor, alternator, etc. Requires complete circuit connection with I2-. See Figure 11 and 12.	
I2-	Negative (dry contacts) connection of Digital Input 2. Connect when using an external device to control Drive.	Can be from V- or from the negative side of an external power supply. Requires complete circuit connection with I2+. See Figure 11 and 12.	
O1+	Output relay (dry contacts) connection. Programmed to close when pump is <i>Running</i> or <i>Faulted</i> .	Positive wires of an external device. See Figures 13 and 14.	Accepts up to 5 Amps at 24VDC and 8 Amps at up to 230VAC
O1+	Output relay (dry contacts) connection. Programmed to close when pump is <i>Running</i> or <i>Faulted</i> .	Positive wires of an external device. See Figures 13 and 14.	
P	Positive connection of an RS-485 communication device (see Figure 15).	Positive wire from RS-485 device.	Per RS-485 Standard
N	Negative connection of an RS-485 communication device (see Figure 15).	Negative wire from RS-485 device.	

RS-485 Communications

RS-485 is a US-based telecommunications standard for binary serial communications between devices. It is the protocol, or set of specifications, that needs to be followed to allow devices that implement the standard to speak to each other. A fully compliant RS-485 port is included in the PENTEK INTELLIDRIVE system to permit serial connections among more than two devices on an RS-485 compliant network. Figure 15 shows two-wire connection to the Drive.

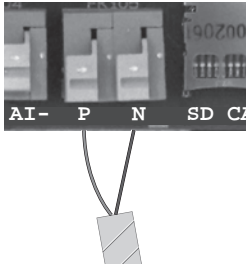

Figure 19 - Example RS-485 Connection

Lightning/Surge Protection

Lightning arrestors or other surge suppressing devices can be used with this product. MOV (Metal Oxide Varistor), SOV (Silicon Oxide Varistor).

Accessories

Part Description	Qty	Part Number
Alternating Control Panel	1	VFD-ALT
Moisture Sensor	1	VFD-WS
Surge Protection Kits	1	VFD-SGA
300 PSI Transducer	1	U17-2000
Flow Switch	1	U17-1999

Retrofit Applications

When retrofitting an installation with the PENTEK INTELLIDRIVE, most of the preceding text can be applied. As a convenience, the recommended *Service Factor Amps* for non-PENTEK motors is provided in Table 11. Always verify *Service Factor Amp* values from current manufacturer literature.

Table 11 - Service Factor Amps @ 230V

Motor Type	HP	Service Factor Rating, in Amps	
		CentriPro ¹	Franklin ²
2-Wire	1/2	4.7	N/A
	3/4	6.4	
	1	9.1	
	1-1/2	11.0	
CS/CR 3-Wire	1/2	4.9	4.3
	3/4	6.3	5.7
	1	7.2	7.1
	1-1/2	11.1	11.5
	2	12.2	13.2
3-Phase	1/2	2.9	2.9
	3/4	3.9	3.8
	1	4.7	4.7
	1-1/2	6.1	5.9
	2	7.6	8.1
	3	10.1	10.9
	5	17.5	17.8

¹ CentriPro SFA data was taken from the March 2012 BMAID manual on 4/2012.

² Franklin Electric SFA data was taken from the 7/2011 Franklin Electric AIM manual on 4/2012.

NOTICE The PENTEK INTELLIDRIVE will not operate Franklin Electric 2-wire motors.

Repair Parts

Part Description	Qty	Part Number
Input Terminal Block Connector	1	PID-CON2
Output Terminal Block Connector	1	PID-CON3
Cooling Fan	1	PID-FAN-R
Pressure Transducer	1	U17-1561-R
10' Transducer Cable	1	U18-1593
25' Transducer Cable*	1	U18-1594
50' Transducer Cable*	1	U18-1595
100' Transducer Cable*	1	U18-1596
150' Transducer Cable*	1	U18-1597
200' Transducer Cable*	1	U18-1598
Keypad	1	PID-HMI-R

* Purchase Separately

Fault	Possible Causes	Solution
Over Current	Shorted output	Check for any shorts in motor cables.
	Locked rotor	Check for debris in pump.
	Damaged wire insulation	Check motor wire insulation with a megger.
Over Voltage	Internal Drive short	With power to Drive off, measure outputs with ohmmeter to detect short.
	Power cycling on and off	Check for a generator or switching on input line.
	High line voltage	Measure incoming line voltage to Drive; should be between 190V and 265V.
Low line voltage		
Under Voltage	Temporary loss of power	Check for local power outage.
	Excessive load current	Check motor is correctly sized for the application.
	Loss of a motor phase	Check correct voltage is present on all motor leads.
	Power was removed from Drive	Check correct voltage is present on all input lines.
Cannot Start Motor	Exceeding <i>Service Factor Amps</i>	Check <i>Service Factor Amps</i> entered are correct.
		Check pump and motor are correct.
	No <i>Service Factor Amps</i> value entered	Check <i>Service Factor Amps</i> entered and are correct.
	There is an open (connection) in motor wires	Check resistance of all motor wires is correct.
	Locked rotor	Pull pump check for debris in pump.
Dry Run	Operation at open discharge	May need to reduce <i>Dry Run Sensitivity</i> pressure or apply back pressure on transducer.
	Drive cannot read transducer signal	Check linearity of transducer, as it may be damaged. See <i>Troubleshooting Guide</i> for more information.
	Possible leak	Check for pipe break or large leak.
	Dry running pump	Check water level in well.
Ground Fault	Ground wire shorted to motor phase	Check the ground wire for short to motor phase wire or check insulation integrity with a megger.
	Long motor cable length	If motor cable length is more than 1000 ft a reactor or filter may be needed to limit capacitance between motor wires.
System Not Grounded	Ungrounded Drive	<i>Ground Detect</i> parameter can be disabled, but will reactivate after 72 hours.

*For additional Troubleshooting information, please visit www.sta-rite.com/resources/images/16455.pdf for a downloadable guide.

Troubleshooting, Continued

Fault	Possible Causes	Solution
<i>Open Transducer</i>	Intermittent connection	Check all transducer wires are securely connected or for damaged cable insulation.
	Open Connection	Check for proper wiring of all transducer wires and verify cable connector securely attached to transducer.
	Drive cannot read transducer signal	Check electrical system for ground loops or no ground connection.
	Transducer wires crossed	Check red is in AI+ and black is in AI-.
	Possible failed transducer	Check linearity of transducer; see <i>Troubleshooting Guide</i> for more information.
<i>Shorted Transducer</i>	Short in transducer wires	Check for shorted transducer wire or damaged insulation.
	Possible failed transducer	Check linearity of transducer; see <i>Troubleshooting Guide</i> for more information.
<i>Over Temperature</i>	Excessive heating in drive	Check ambient temperature is not above 50°C (122°F).
		Check for inoperable or unobstructed fan.
		Check vents are not obstructed.
<i>Excessive Runtime</i>	Leak detected	Check for leaks in pipe system.
	Application calls for long run times	Extend <i>Excessive Runtime Hours</i> limitation. Disable <i>Excessive Runtime Fault</i> .
<i>Internal Fault</i>	Internal voltages are out of range	Drive will auto reset and attempt to clear fault. <i>Fault Reset</i> can be pressed to clear fault as well. Then try to operate pump. If fault continues Drive may need replacement.
<i>Hardware Fault</i>	Internal hardware failure	<i>Fault Reset</i> can be pressed to clear fault. Then try to operate pump. If fault continues Drive may need replacement.
<i>External Fault</i>	The external device detected fault condition and closed the I1 or I2 input	Check external device.
<i>Low Amps</i>	Under-sized pump	Increase <i>Minimum Speed</i> to 35 Hz.
	Low current draw from pump	
	Thermal protector open in motor (3 wire)	Wait 20 minutes then restart pump.
	Missing motor phase	Check all motor connections at the Drive.

Troubleshooting, Continued

Warning	Possible Causes	Solution
<i>Warning LED flashing</i>	Ungrounded Drive, with ground detection parameter disabled (will operate for 72 hours and then fault).	Verify ground wire is connected on both incoming voltage side and motor side of Drive.
		With power disconnected, use ohmmeter to verify the pipe the transducer is connected to and that input ground wire are at same potential (approx 0 ohms).
		Verify the input ground is connected all the way back to electrical panel.
<i>Jam Warning</i>	Debris in pump stopping motor from turning (locked rotor).	Drive tries to free debris in pump by reversing or pulsing motor.
<i>Over Pressure Warning</i>	Pressure rising above <i>Over Pressure</i> setting.	Drive stops and waits 1 minute, then checks that pressure is below the <i>Setpoint</i> pressure. Below it restarts, if not checks again in another minute. Can increase over-pressure value.

Drive Reset Procedure

Follow the keypress sequence shown at right to test the Drive.

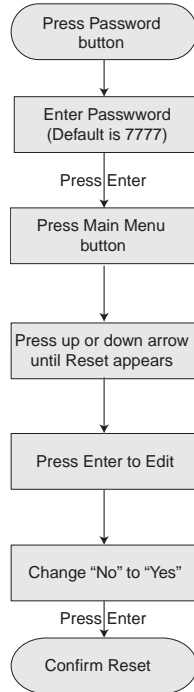

Figure 20 - Drive Reset Procedure

NOTICE In a domestic environment, this product may cause radio interference which may require supplementary mitigation measures.

Limited Warranty

PENTAIR warrants to the original consumer purchaser (“Purchaser” or “You”) of the products listed below, that they will be free from defects in material and workmanship for the Warranty Period shown below.

Product	Warranty Period
Water Systems Products — jet pumps, small centrifugal pumps, submersible pumps and related accessories	<i>whichever occurs first:</i> 12 months from date of original installation, 18 months from date of manufacture
PENTEK INTELLIDRIVE™	12 months from date of original installation, or 18 months from date of manufacture
Pro-Source™ Composite Tanks	5 years from date of original installation
Pro-Source™ Steel Pressure Tanks	5 years from date of original installation
Pro-Source™ Epoxy-Line Tanks	3 years from date of original installation
Sump/Sewage/Effluent Products	12 months from date of original installation, or 18 months from date of manufacture

Our warranty will not apply to any product that, in our sole judgment, has been subject to negligence, misapplication, improper installation, or improper maintenance. Without limiting the foregoing, operating a three phase motor with single phase power through a phase converter will void the warranty. Note also that three phase motors must be protected by three-leg, ambient compensated, extra-quick trip overload relays of the recommended size or the warranty is void.

Your only remedy, and PENTAIR’s only duty, is that PENTAIR repair or replace defective products (at PENTAIR’s choice). You must pay all labor and shipping charges associated with this warranty and must request warranty service through the installing dealer as soon as a problem is discovered. No request for service will be accepted if received after the Warranty Period has expired. This warranty is not transferable.

PENTAIR IS NOT LIABLE FOR ANY CONSEQUENTIAL, INCIDENTAL, OR CONTINGENT DAMAGES WHATSOEVER. THE FOREGOING LIMITED WARRANTIES ARE EXCLUSIVE AND IN LIEU OF ALL OTHER EXPRESS AND IMPLIED WARRANTIES, INCLUDING BUT NOT LIMITED TO IMPLIED WARRANTIES OF MERCHANTABILITY AND FITNESS FOR A PARTICULAR PURPOSE. THE FOREGOING LIMITED WARRANTIES SHALL NOT EXTEND BEYOND THE DURATION PROVIDED HEREIN.

Some states do not allow the exclusion or limitation of incidental or consequential damages or limitations on how long an implied warranty lasts, so the above limitations or exclusions may not apply to You. This warranty gives You specific legal rights and You may also have other rights which vary from state to state.

This Limited Warranty is effective June 1, 2011 and replaces all undated warranties and warranties dated before June 1, 2011.

PENTAIR
 293 Wright Street • Delavan, WI 53115
 Phone (262) 728-5551 • Fax (262) 728-7323

